

# DIGITAST

## Microminiature SPDT, Key Switches



### Features/Benefits

- High reliability / long life
- Designed for low level switching
- Ready to implement on PCB
- Latching function available
- Several button options

### Typical Applications

- Medical
- Instrumentation
- Industrial electronics
- Audio electronics

### Construction

FUNCTION: momentary or push-push  
 CONTACT ARRANGEMENT: 1 change over contact SPDT, NO  
 MODE OF SWITCHING: Non-shorting  
 DISTANCE BETWEEN BUTTON CENTERS:  
 HORIZONTAL MINIMUM: 12,7 (0.500) or 17,78 (0.700)  
 VERTICAL MINIMUM: 17,78 (0.700)  
 TERMINALS: PC pins  
 MOUNTING: Soldering, centering pins

### Mechanical

TOTAL TRAVEL:  $\leq 3$  (.0018)  
 SWITCHING TRAVEL: 1,5 (0.0591)  
 LATCHING TRAVEL: 1,8 (0.0709)  
 OPERATING FORCE: 1.5 +/- 0.5 N (150 +/- 50 grams)

### Process

SOLDERABILITY: Sealed contacts  
 Max. soldering time and temperature: 5 s at 260°C

### Electrical

SWITCHING POWER MAX.: 240 mW DC  
 SWITCHING VOLTAGE MAX.: 24 V DC  
 SWITCHING CURRENT MAX.: 10 mA DC  
 SPACING CURRENT AT 20°C (push-push version): 100 mA  
 DIELECTRIC STRENGTH (50 Hz, 1 min): 500 V  
 OPERATING LIFE with or without max. switching power  
 Momentary:  $\geq 5 \times 10^6$  operations  
 Push-push:  $\geq 5 \times 10^5$  operations  
 CONTACT RESISTANCE: Initial  $\leq 50$  m $\Omega$   
 After  $5 \times 10^6$  operations:  $\leq 100$  m $\Omega$   
 INSULATION RESISTANCE:  $\geq 10^{10}$   $\Omega$   
 CAPACITANCE at f= 10 kHz:  $\leq 0.8$  pF  
 BOUNCE TIME:  $\leq 2.5$  ms  
 Operating speed 400 mm/s (15.75/s)

### Environmental

OPERATING TEMPERATURE: -25°C to 85°C.

### How To Order

Our easy build-a-switch concept allows you to mix and match options to create the switch you need. To order, select desired option from each category and place it in the appropriate box.

#### Switch with Button

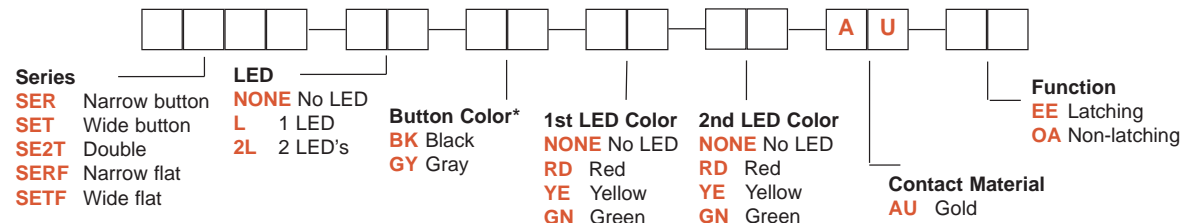

#### Button Only

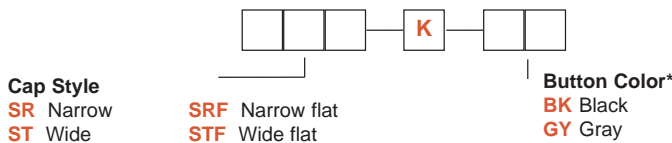

\* Additional button colors available by request

# DIGITAST Microminiature SPDT, Key Switches

DESIGNATION

## SER Narrow button

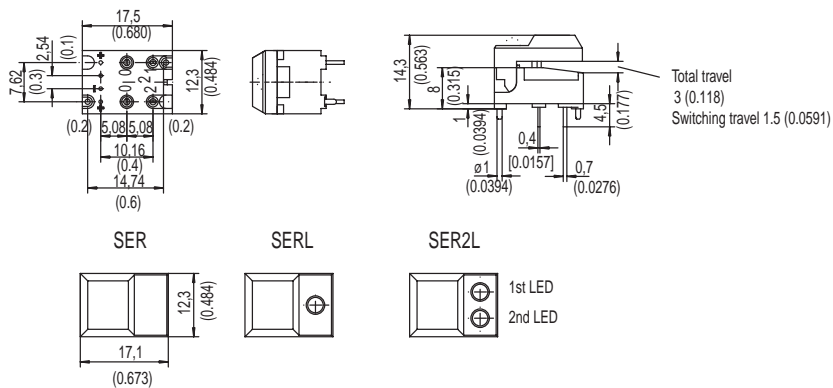

## SET Wide button

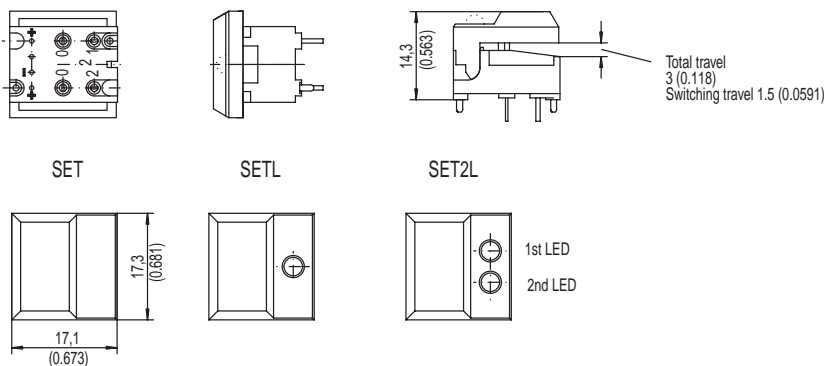

## SE2T Double

SE2T, SE2TL, SE2T2L

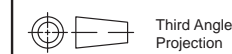
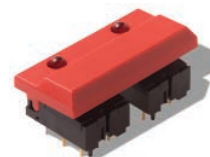
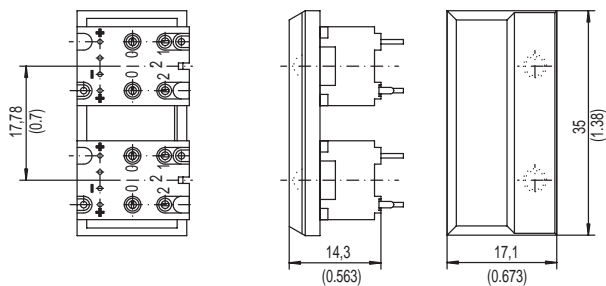

Dimensions shown in: mm (Inch)  
Dimensions subject to change

# DIGITAST Microminiature SPDT, Key Switches

## DESIGNATION

**SERF** Narrow flat

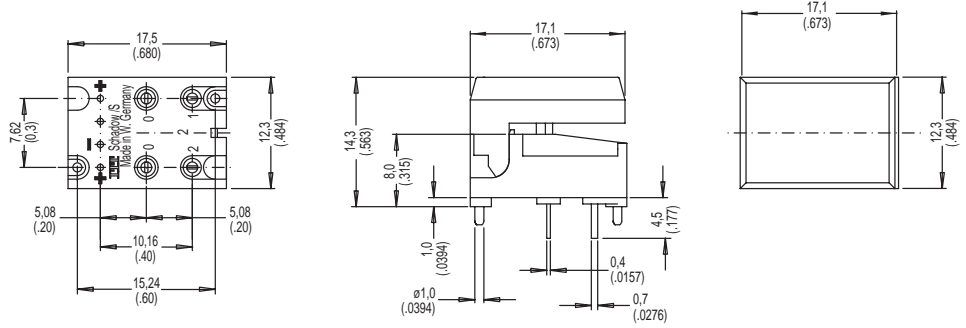

**SETF** Wide flat

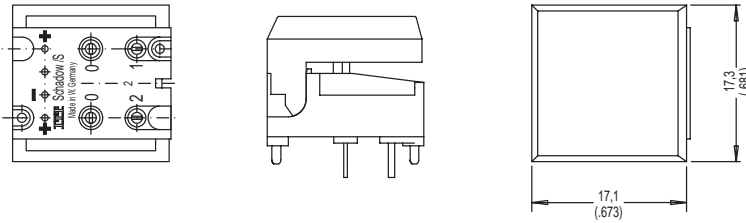

## LED

**NONE** No LED

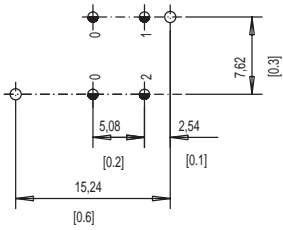

**L** 1 LEDs

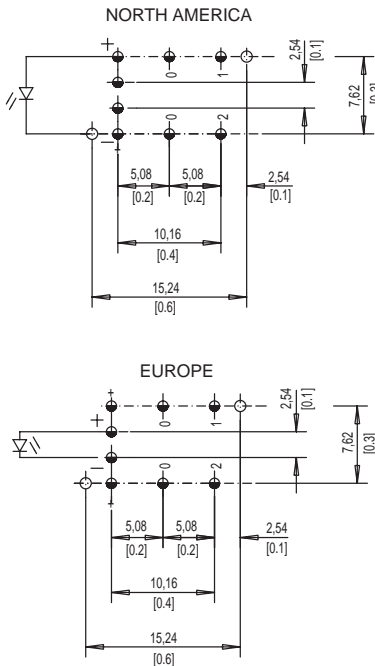

**2L** 2 LEDs

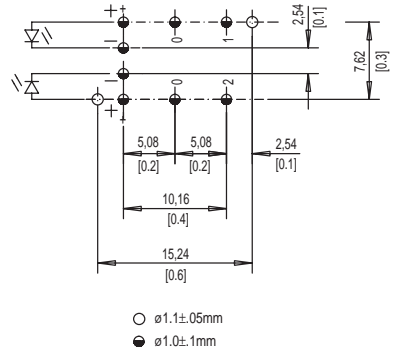

Soldering Side - Bottom View

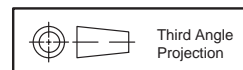

D

Key Switches

# DIGITAST Microminiature SPDT, Key Switches

## BUTTON COLOR

**BK** Black

**GY** Gray

Other button colors available by request (red (RD), green (GN), white (WH), yellow (YE), blue (BU), orange (OG)).

## LED COLOR

OPTION CODE	COLOR
<b>NONE</b>	Models without LED
<b>RD</b>	Red
<b>GN</b>	Green
<b>YE</b>	Yellow

## CONTACT MATERIAL

OPTION CODE	MATERIAL
<b>AU</b>	Gold

## FUNCTION

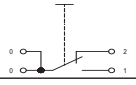
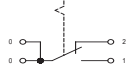
OPTION CODE	COLOR	SCHEMATIC
<b>OA</b>	Momentary	
<b>EE</b>	Push-Push	



D

Key Switches