

Optocoupler with Phototransistor Output

Description

The 4N35/ 4N36/ 4N37 consist of a phototransistor optically coupled to a gallium arsenide infrared-emitting diode in a 6-lead plastic dual inline package. The elements are mounted on one leadframe using a **coplanar technique**, providing a fixed distance between input and output for highest safety requirements.

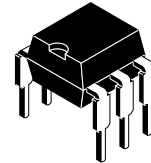

95 10532

Applications

Galvanically separated circuits for general purposes

Features

- Isolation test voltage (RMS) 3.75 kV
- Underwriters Laboratory (UL) 1577 recognized, file number E-76222
- Low coupling capacity of typical 0.3 pF
- **C**urrent **T**ransfer **R**atio (CTR) > 100%
- Low temperature coefficient of CTR

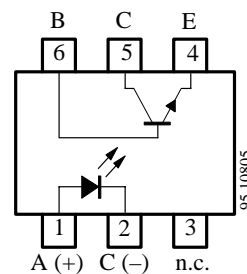

Order Instruction

Ordering Code	CTR Ranking	Remarks
4N35	> 100%	
4N36	> 100%	
4N37	> 100%	



Absolute Maximum Ratings

Input (Emitter)

Parameter	Test Conditions	Symbol	Value	Unit
Reverse voltage		V_R	6	V
Forward current		I_F	60	mA
Forward surge current	$t_p \leq \mu s$	I_{FSM}	3	A
Power dissipation	$T_{amb} \leq 25^\circ C$	P_V	100	mW
Junction temperature		T_j	125	$^\circ C$

Output (Detector)

Parameter	Test Conditions	Symbol	Value	Unit
Collector base voltage		V_{CBO}	70	V
Collector emitter voltage		V_{CEO}	30	V
Emitter collector voltage		V_{ECO}	7	V
Collector current		I_C	50	mA
Peak collector current	$t_p/T = 0.5, t_p \leq 10 \text{ ms}$	I_{CM}	100	mA
Power dissipation	$T_{amb} \leq 25^\circ C$	P_V	150	mW
Junction temperature		T_j	125	$^\circ C$

Coupler

Parameter	Test Conditions	Symbol	Value	Unit
Isolation test voltage (RMS)	$t = 1 \text{ min}$	$V_{IO}^{1)}$	3.75	kV
Total power dissipation	$T_{amb} \leq 25^\circ C$	P_{tot}	250	mW
Ambient temperature range		T_{amb}	-55 to +100	$^\circ C$
Storage temperature range		T_{stg}	-55 to +125	$^\circ C$
Soldering temperature	2 mm from case, $t \leq 10 \text{ s}$	T_{sd}	260	$^\circ C$

¹⁾ Related to standard climate 23/50 DIN 50014



Electrical Characteristics ($T_{amb} = 25^{\circ}\text{C}$)

Input (Emitter)

Parameter	Test Conditions	Symbol	Min.	Typ.	Max.	Unit
Forward voltage	$I_F = 10\text{ mA}$	V_F		1.2	1.5	V
Forward voltage	$I_F = 10\text{ mA}$, $T_{amb} = 100^{\circ}\text{C}$	V_F			1.4	V
Junction capacitance	$V_R = 0$, $f = 1\text{ MHz}$	C_j		50		pF

Output (Detector)

Parameter	Test Conditions	Symbol	Min.	Typ.	Max.	Unit
Collector base voltage	$I_C = 100\text{ }\mu\text{A}$	V_{CBO}	70			V
Collector emitter voltage	$I_C = 1\text{ mA}$	V_{CEO}	30			V
Emitter collector voltage	$I_E = 100\text{ }\mu\text{A}$	V_{ECO}	7			V
Collector dark current	$I_F = 0$, $E = 0$, $V_{CE} = 10\text{ V}$	I_{CEO}		5	50	nA
	$I_F = 0$, $E = 0$, $V_{CE} = 30\text{ V}$, $T_{amb} = 100^{\circ}\text{C}$	I_{CEO}			500	μA

Coupler

Parameter	Test Conditions	Symbol	Min.	Typ.	Max.	Unit
Isolation test voltage (RMS)	$f = 50\text{ Hz}$, $t = 2\text{ s}$	$V_{IO}^{1)}$	3.75			kV
Isolation resistance	$V_{IO} = 1\text{ kV}$, 40% relative humidity	$R_{IO}^{1)}$		10^{12}		Ω
Collector emitter saturation voltage	$I_F = 10\text{ mA}$, $I_C = 0.5\text{ mA}$	V_{CEsat}			0.3	V
Cut-off frequency	$I_F = 10\text{ mA}$, $V_{CE} = 5\text{ V}$, $R_L = 100\text{ }\Omega$	f_c		110		kHz
Coupling capacitance	$f = 1\text{ MHz}$	C_k		0.3		pF

¹⁾ Related to standard climate 23/50 DIN 50014

Current Transfer Ratio (CTR)

Parameter	Test Conditions	Type	Symbol	Min.	Typ.	Max.	Unit
I_C/I_F	$V_{CE} = 10\text{ V}$, $I_F = 10\text{ mA}$	4N35, 4N36, 4N37	CTR	1			
	$V_{CE} = 10\text{ V}$, $I_F = 10\text{ mA}$, $T_{amb} = 100^{\circ}\text{C}$	4N35, 4N36, 4N37	CTR	0.4			



Switching Characteristics

Parameter	Test Conditions	Symbol	Typ.	Unit
Turn-on time (typical)	$V_S = 10\text{ V}$, $I_C = 2\text{ mA}$, $R_L = 100\ \Omega$ (see figure 1)	t_{on}	5.5	μs
Turn-on time (maximum)		t_{on}	10.0	μs
Turn-off time (typical)		t_{off}	4.5	μs
Turn-off time (maximum)		t_{off}	10.0	μs
Turn-on time	$V_S = 5\text{ V}$, $I_F = 10\text{ mA}$, $R_L = 1\text{ k}\Omega$ (see figure 2)	t_{on}	9.0	μs
Turn-off time		t_{off}	18.0	μs

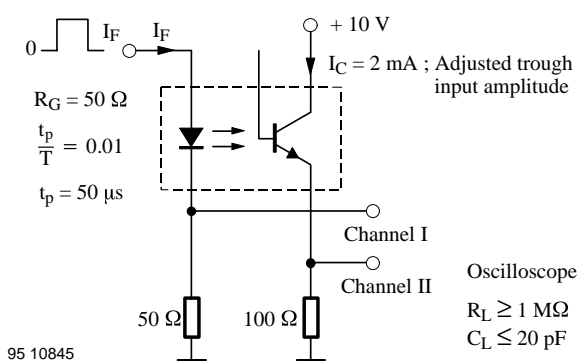

Figure 1. Test circuit, non-saturated operation

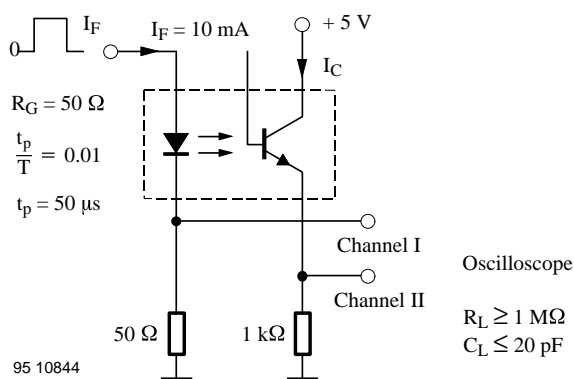

Figure 2. Test circuit, saturated operation

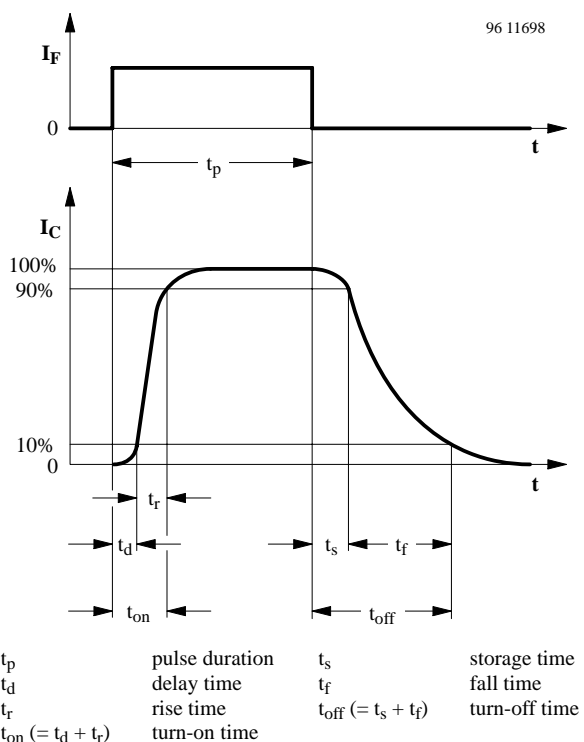

Figure 3. Switching times

Typical Characteristics ($T_{amb} = 25^{\circ}\text{C}$, unless otherwise specified)

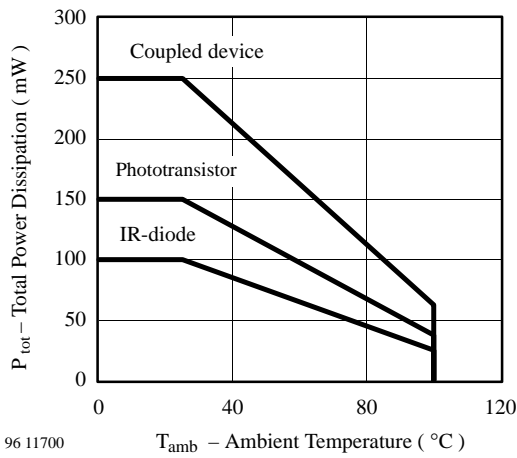

Figure 4. Total Power Dissipation vs. Ambient Temperature

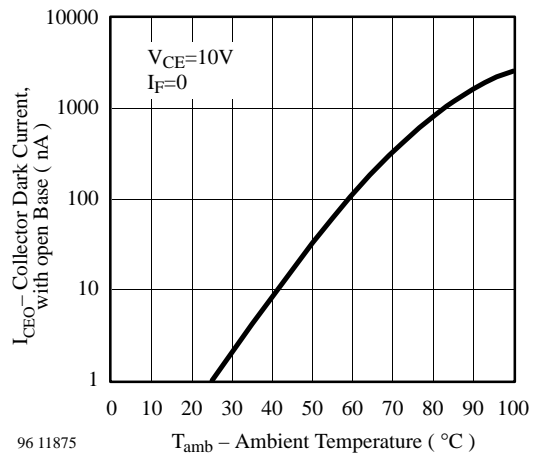

Figure 7. Collector Dark Current vs. Ambient Temperature

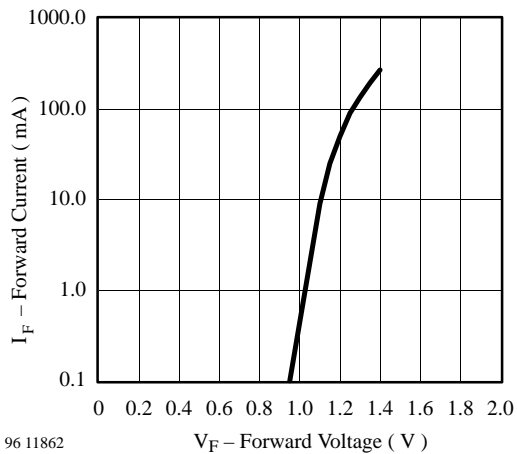

Figure 5. Forward Current vs. Forward Voltage

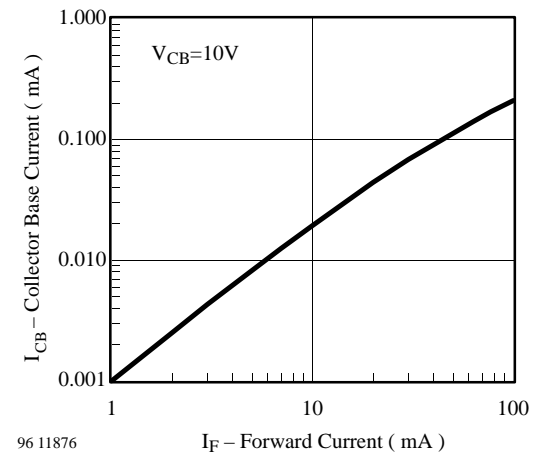

Figure 8. Collector Base Current vs. Forward Current

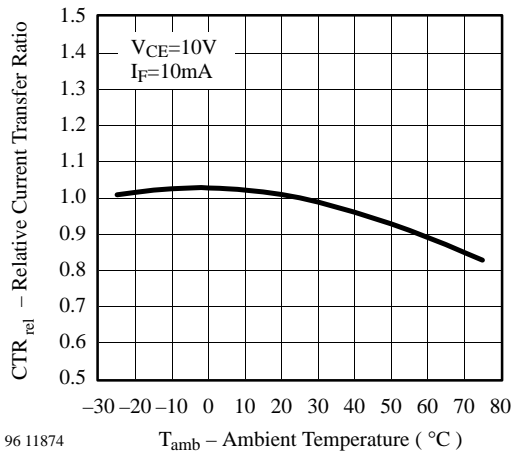

Figure 6. Relative Current Transfer Ratio vs. Ambient Temperature

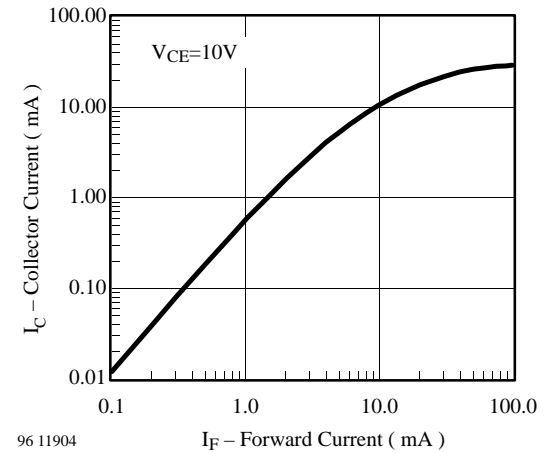

Figure 9. Collector Current vs. Forward Current

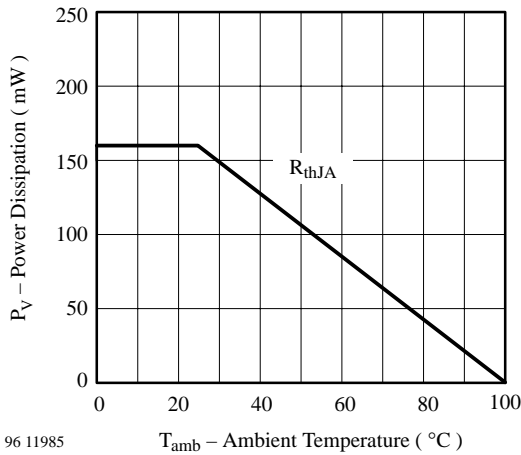

Figure 10. Collector Current vs. Collector Emitter Voltage

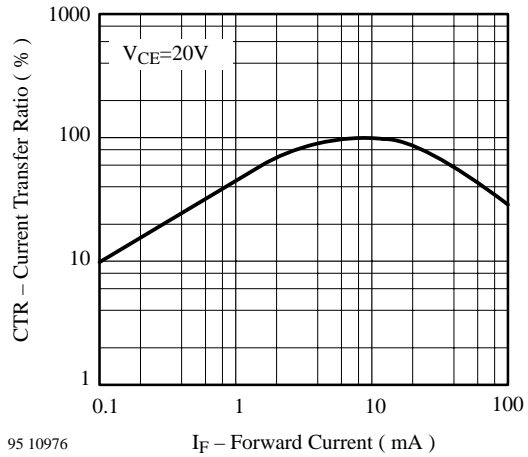

Figure 13. Current Transfer Ratio vs. Forward Current

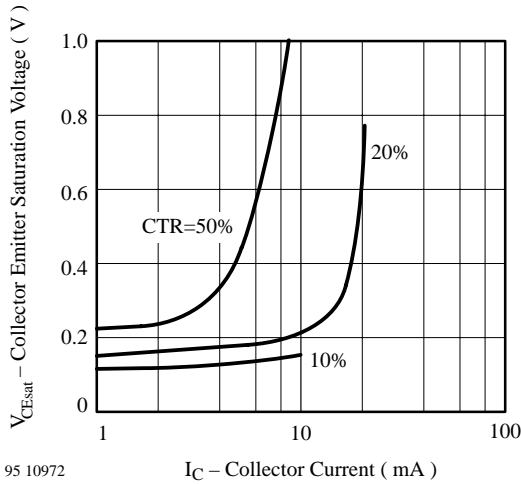

Figure 11. Collector Emitter Saturation Voltage vs. Collector Current

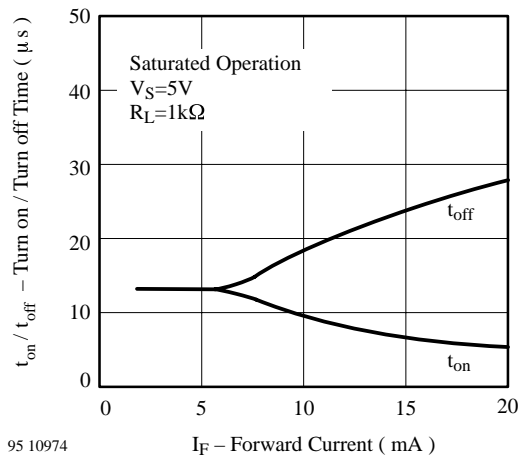

Figure 14. Turn on / off Time vs. Forward Current

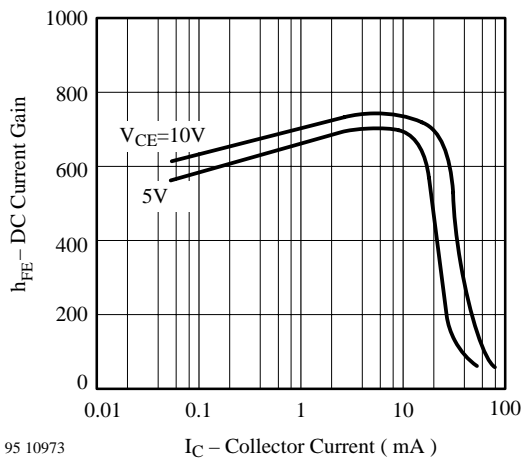

Figure 12. DC Current Gain vs. Collector Current

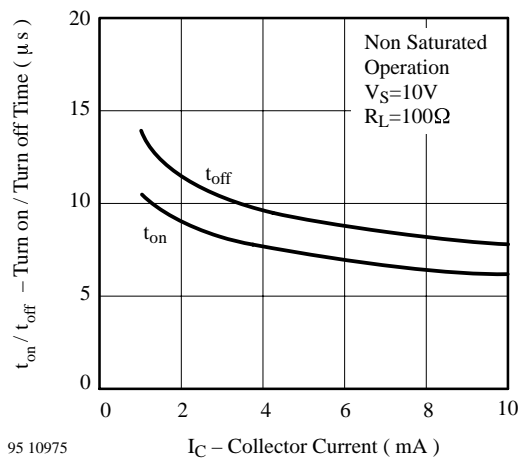

Figure 15. Turn on / off Time vs. Collector Current

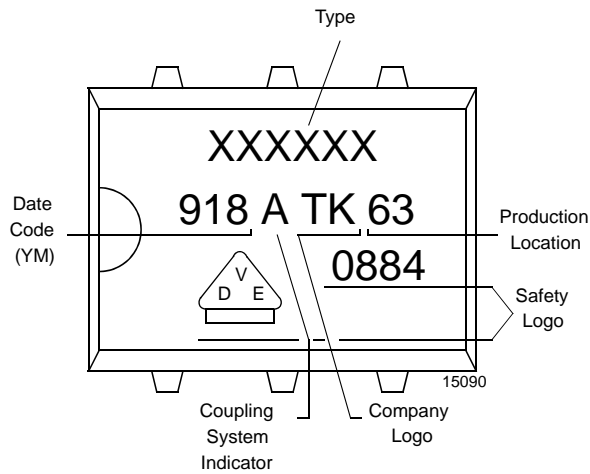
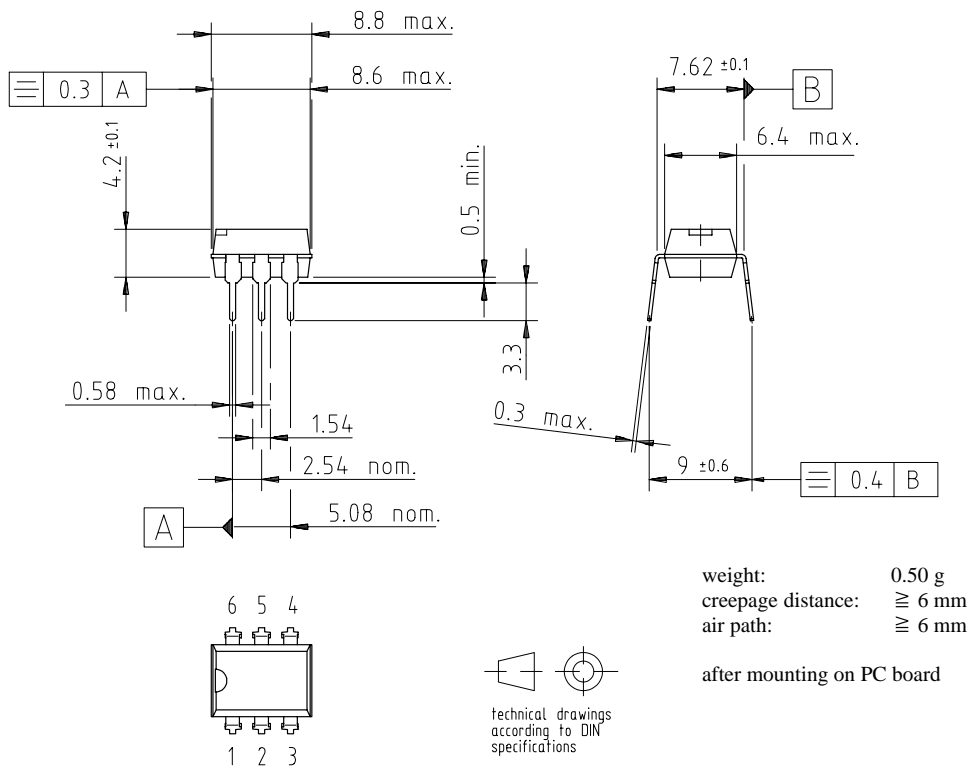

Figure 16. Marking example

Dimensions of 4N3. in mm



14770



Ozone Depleting Substances Policy Statement

It is the policy of **Vishay Semiconductor GmbH** to

1. Meet all present and future national and international statutory requirements.
2. Regularly and continuously improve the performance of our products, processes, distribution and operating systems with respect to their impact on the health and safety of our employees and the public, as well as their impact on the environment.

It is particular concern to control or eliminate releases of those substances into the atmosphere which are known as ozone depleting substances (ODSs).

The Montreal Protocol (1987) and its London Amendments (1990) intend to severely restrict the use of ODSs and forbid their use within the next ten years. Various national and international initiatives are pressing for an earlier ban on these substances.

Vishay Semiconductor GmbH has been able to use its policy of continuous improvements to eliminate the use of ODSs listed in the following documents.

1. Annex A, B and list of transitional substances of the Montreal Protocol and the London Amendments respectively
2. Class I and II ozone depleting substances in the Clean Air Act Amendments of 1990 by the Environmental Protection Agency (EPA) in the USA
3. Council Decision 88/540/EEC and 91/690/EEC Annex A, B and C (transitional substances) respectively.

Vishay Semiconductor GmbH can certify that our semiconductors are not manufactured with ozone depleting substances and do not contain such substances.

We reserve the right to make changes to improve technical design and may do so without further notice.

Parameters can vary in different applications. All operating parameters must be validated for each customer application by the customer. Should the buyer use Vishay Semiconductors products for any unintended or unauthorized application, the buyer shall indemnify Vishay Semiconductors against all claims, costs, damages, and expenses, arising out of, directly or indirectly, any claim of personal damage, injury or death associated with such unintended or unauthorized use.

Vishay Semiconductor GmbH, P.O.B. 3535, D-74025 Heilbronn, Germany
Telephone: 49 (0)7131 67 2831, Fax number: 49 (0)7131 67 2423